

**По вопросам продаж и поддержки обращайтесь:**

Архангельск (8182)63-90-72  
Астана +7(7172)727-132  
Белгород (4722)40-23-64  
Брянск (4832)59-03-52  
Владивосток (423)249-28-31  
Волгоград (844)278-03-48  
Вологда (8172)26-41-59  
Воронеж (473)204-51-73  
Екатеринбург (343)384-55-89  
Иваново (4932)77-34-06  
Ижевск (3412)26-03-58  
Казань (843)206-01-48

Калининград (4012)72-03-81  
Калуга (4842)92-23-67  
Кемерово (3842)65-04-62  
Киров (8332)68-02-04  
Краснодар (861)203-40-90  
Красноярск (391)204-63-61  
Курск (4712)77-13-04  
Липецк (4742)52-20-81  
Магнитогорск (3519)55-03-13  
Москва (495)268-04-70  
Мурманск (8152)59-64-93  
Набережные Челны (8552)20-53-41

Нижний Новгород (831)429-08-12  
Новокузнецк (3843)20-46-81  
Новосибирск (383)227-86-73  
Орел (4862)44-53-42  
Оренбург (3532)37-68-04  
Пенза (8412)22-31-16  
Пермь (342)205-81-47  
Ростов-на-Дону (863)308-18-15  
Рязань (4912)46-61-64  
Самара (846)206-03-16  
Санкт-Петербург (812)309-46-40  
Саратов (845)249-38-78

Смоленск (4812)29-41-54  
Сочи (862)225-72-31  
Ставрополь (8652)20-65-13  
Тверь (4822)63-31-35  
Томск (3822)98-41-53  
Тула (4872)74-02-29  
Тюмень (3452)66-21-18  
Ульяновск (8422)24-23-59  
Уфа (347)229-48-12  
Челябинск (351)202-03-61  
Череповец (8202)49-02-64  
Ярославль (4852)69-52-93

сайт: <http://induction.nt-rt.ru> || эл. почта: [ick@nt-rt.ru](mailto:ick@nt-rt.ru)

## **Технические характеристики**



1.

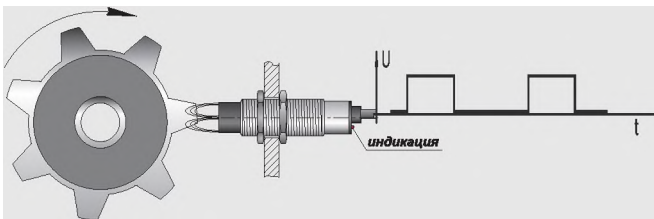

1.

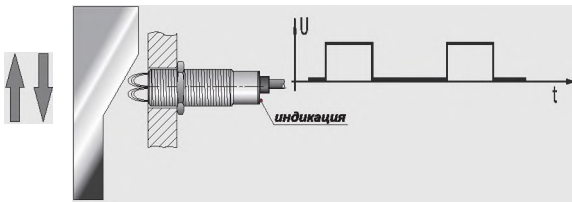

40.....	1
.....	0,8
.....	0,5
.....	0,45
.....	0,45

1.

( 40) 1  
3xSn  
3xSn.  
S/Sn-

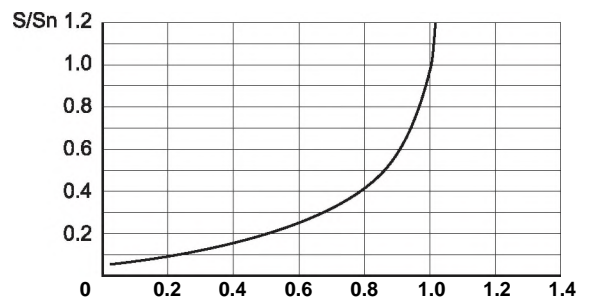

1.

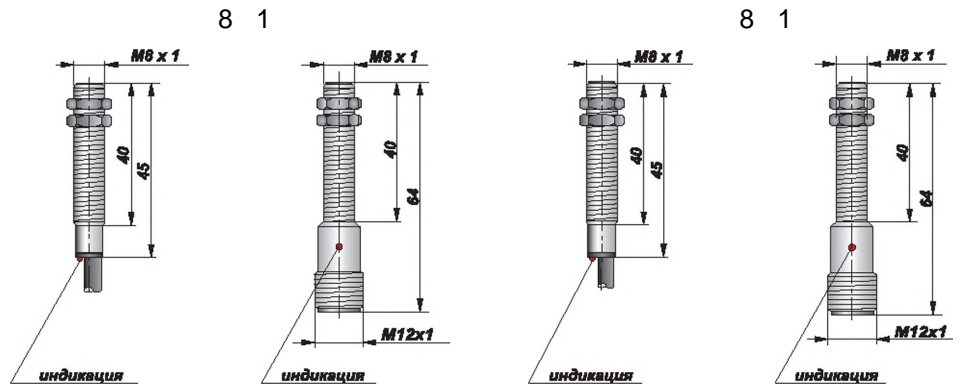

		Sn	2,5		2,5		3,5		3,5	
PNP		-	MB81-NO-PNP	01475	HB81-NO-PNP-P	01479	MB82-NO-PNP	01483	HB82-NO-PNP-P	01487
	⊙	-	MB81-NC-PNP	01476	HB81-NC-PNP-P	01480	MB82-NC-PNP	01484	HB82-NC-PNP-P	01488
NPN	⊙	-	MB81-NO-NPN	01477	81-NO-NPN-P	01481	MB82-NO-NPN	01485	HB82-NO-NPN-P	01489
	⊙	-	MB81-NC-NPN	01478	HB81-NC-NPN-P	01482	MB82-NC-NPN	01486	HB82-NC-NPN-P	01490

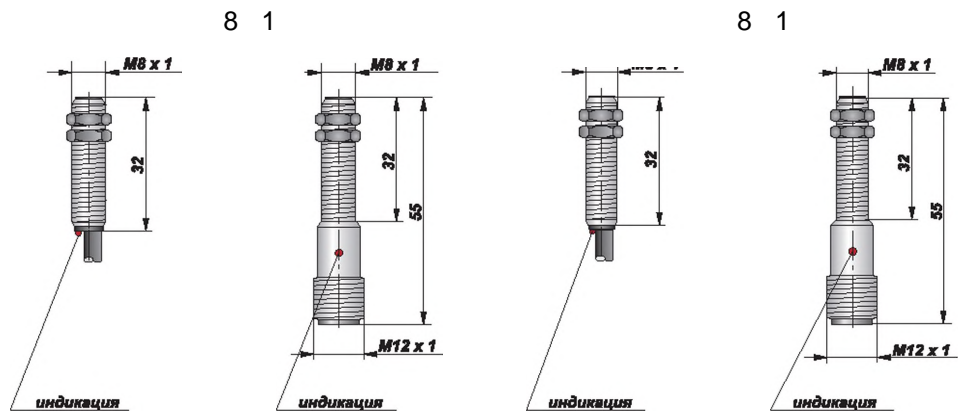

		Sn	2,5		2,5		3,5		3,5	
PNP		-	HB83-NO-PNP	01491	-NO-PNP-P	01495	HB84-NO-PNP	01499	HB84-NO-PNP-P	01503
	⊙	-	HB83-NC-PNP	01492	HB83-NC-PNP-P	01596	HB84-NC-PNP	01500	HB84-NC-PNP-P	01504
NPN	⊙	-	HB83-NO-NPN	01493	HB83-NO-NPN-P	01497	MB84-NO-NPN	01501	HB84-NO-NPN-P	01505
	⊙	-	HB83-NC-NPN	01494	HB83-NC-NPN-P	01498	HB84-NC-NPN	01502	HB84-NC-NPN-P	1506

10...30

250

2,1

1500...

1300

10%

10%

-25 ...+75

IP87

63 ( 16 )

Нормально-разомкнутый контакт



Нормально-замкнутый контакт

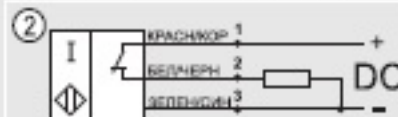

Цоколевка разъема

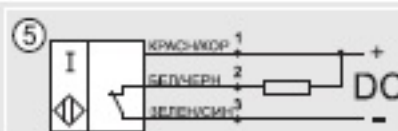
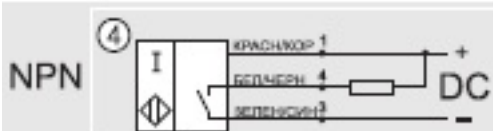

M8 X 0,5

M8 X 0,5

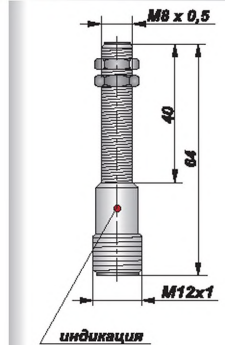
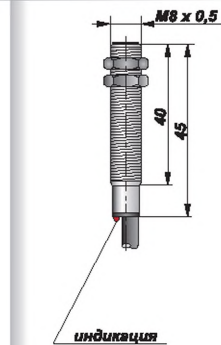
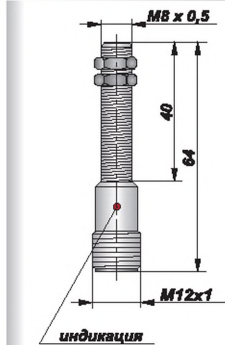
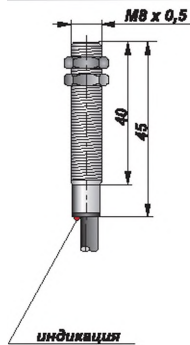

		Sn	2,5		2,5		3,5		3,5	
PNP	-	-	HB85-NO-PNP	01507	HB85-NO-PNP-P	01511	HB86-NO-PNP	01515	HB86-NO-PNP-P	01519
	@	-	HB85-NC-PNP	01508	HB85-NC-PNP-P	01512	HB86-NC-PNP	01516	HB86-NC-PNP-P	01520
NPN	-	-	HB85-NO-NPN	01509	HB85-NO-NPN-P	01513	HB86-NO-NPN	01517	HB86-NO-NPN-P	01521
	@	-	HB85-NC-NPN	01510	HB85-NC-NPN-P	01514	HB86-NC-NPN	01518	-NC-NPN-P	01522

8 0.5

8 0.5

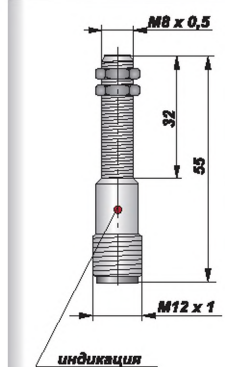
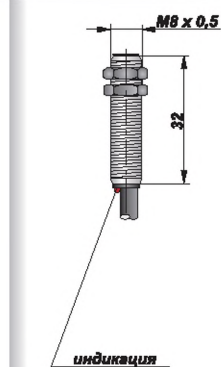
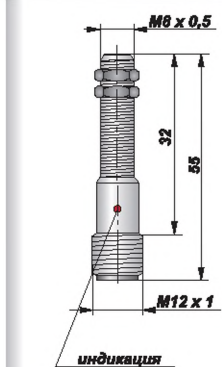
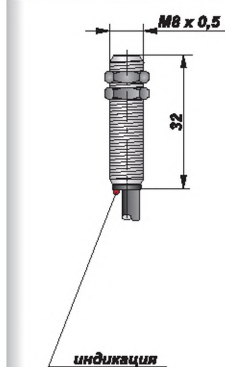

		Sn	2,5		2,5		3,5		3,5	
PNP	-	-	HB87-NO-PNP	01523	HB87-NO-PNP-P	01527	HB88-NO-PNP	01531	MB88-NO-PNP-P	01535
	@	-	HB87-NC-PNP	01524	HB87-NC-PNP-P	01528	HB88-NC-PNP	01532	HB88-NC-PNP-P	HO1536
NPN	-	-	HB87-NO-NPN	01525	HB87-NO-NPN-P	01529	HB88-NO-NPN	01533	HB88-NO-NPN-P	HO1537
	@	-	HB87-NC-NPN	01526	HB87-NC-NPN-P	01530	MB88-NC-NPN	01534	MB88-NC-NPN-P	01538

						10..30
						250
						2,1
						1000   900
						10%
						10%
						-25 ...+75
						IP67
						63 16 )
						/«4



**Типоразмер**

**M12 X 1**

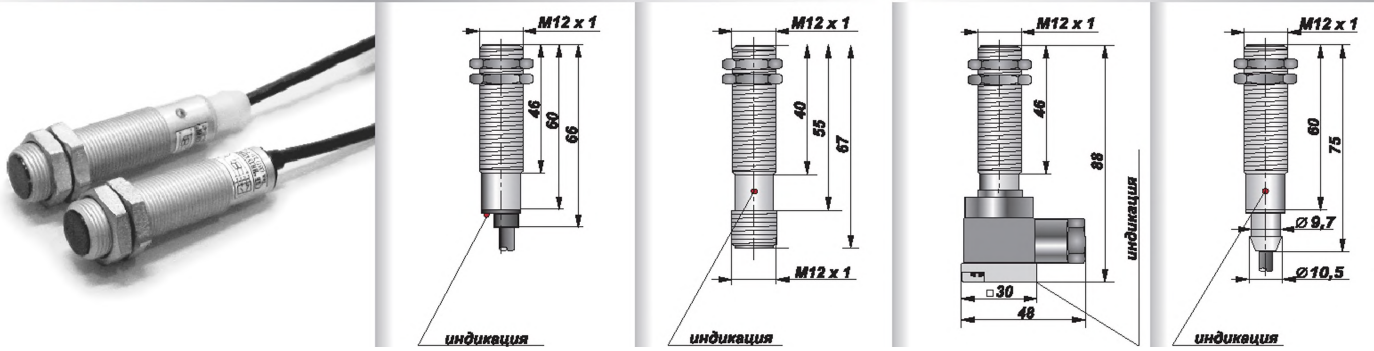

		Sn 4								
PNP	⊕	-	MB01-NO-PNP	01539	HB01-NO-PNP-P	01545	k1B01-NO-PNP-K	01551	HB02-NO-PNP	01557
	⊕	-	MB01-NC-PNP	01540	MB01-NC-PNP-P	01546	HB01-NC-PNP-K	01552	MB02-NC-PNP	01558
	⊕	-	MB01-NO/NC-PNP	01541	01-N O/N - N	01547	01-NO/NC-PNP-K	01553	MB02-NO/NC-PNP	01559
NPN	⊖	-	MB01-NO-NPN	01542	HB01-NO-NPN-P	01548	I4B01-NO-NPN-K	01554	MB02-NO-NPN	01560
	⊖	-	HB01-NC-NPN	01543	MB01-NC-NPN-P	01549	HB01-NC-NPN-K	01555	HB02-NC-NPN	01561
	⊖	-	MB01-NO/NC-NPN	01544	HB01-NO/NC-NPN-P	01550	I4B01-NO/NC-NPN-K	01556	HB02-NO/NC-NPN	01562

**12 1**

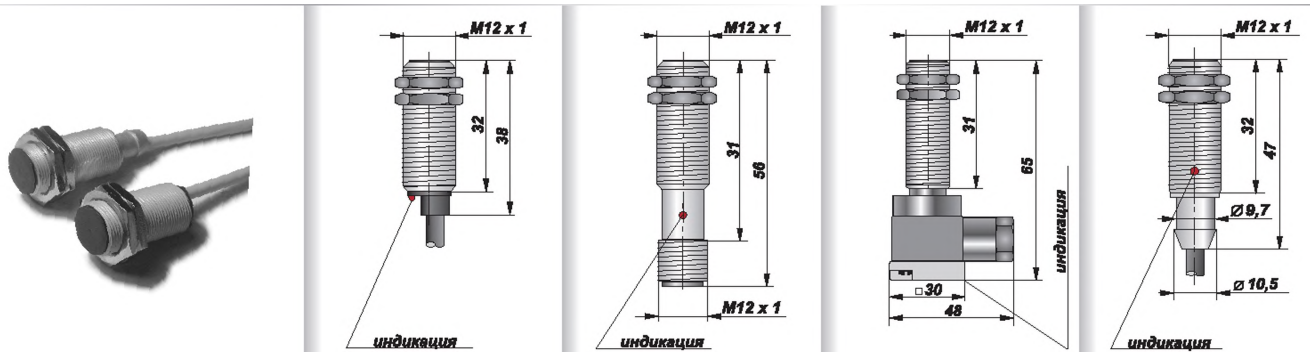

		Sn 4								
PNP	⊕	-	HB05-NO-PNP	01563	HB05-NO-PNP-P	01567	HB05-NO-PNP-K	01571	-NO-PNP	01575
	⊕	-	HB05-NC-PNP	01564	HB05-NC-PNP-P	01568	MB05-NC-PNP-K	01572	-NC-PNP	01576
NPN	⊖	-	MB05-NO-NPN	01565	I4B05-NO-NPN-P	01569	MB05-NO-NPN-K	01573	-NO-NPN	01577
	⊖	-	HB05-NC-NPN	01566	I4B05-NC-NPN-P	01570	MB05-NC-NPN-K	01574	-NC-NPN	01578

						10...30			
						400			
						2,1			
						600			
						10%			
						10%			
						-25 ...+75			
						IP67			
						16 (12 18 10		6)	

**Нормально-разомкнутый контакт**

**Нормально-замкнутый контакт**

**Переключающий контакт**

**Цоколевка разъема**

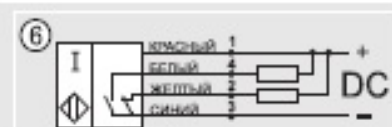
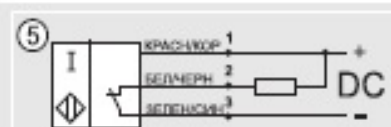
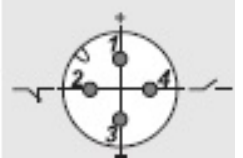
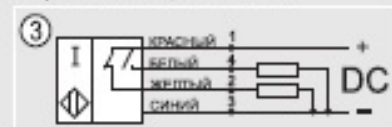
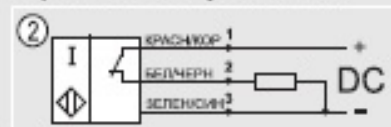
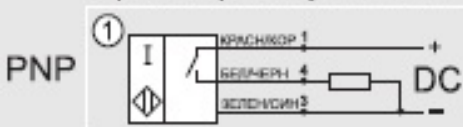





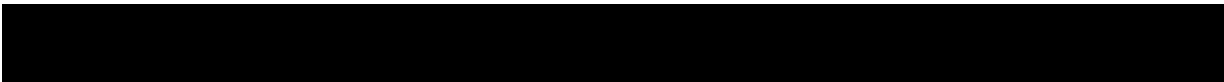

18 1

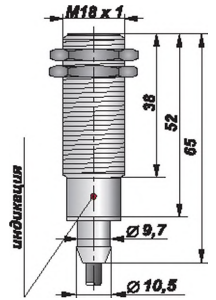
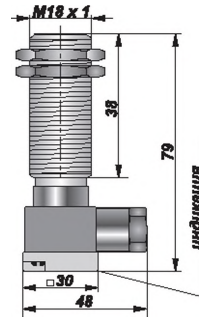
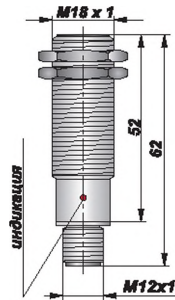
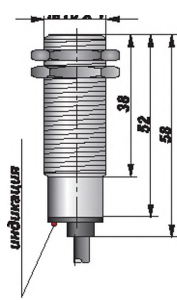

		Sn 8									
PNP	ⓐ	-	HB09-NO-PNP	01619	HB09-NO-PNP-P	01625	-NO-PNP-K	01631	-NO-PNP	01637	
	ⓑ	-	HB09-NC-PNP	01620	MB09-NC-PNP-P	01626	-NC-PNP-K	01632	HB010-NC-PNP	01638	
		-	-NO/N - N	01621	-NO/NC-PNP-P	01627	-NO/NC-PNP-K	01633	-NO/NC-PNP	01639	
NPN	ⓐ	-	HB09-NO-NPN	01622	-NO-NPN-P	01628	-NO-NPN-K	01634	-NO-NPN	01640	
	ⓑ	-	-NC-NPN	01623	-NC-NPN-P	01629	-NC-NPN-K	01635	HB010-NC-NPN	01641	
		-	HB09-NO/NC-NPN	01624	HB09-NO/NC-NPN-P	01630	-NO/NC-NPN-K	01636	-NO/NC-NPN	01642	

18 1

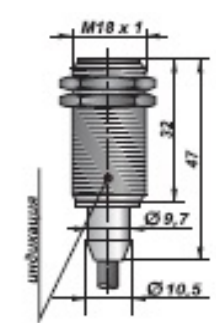
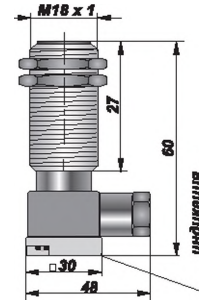
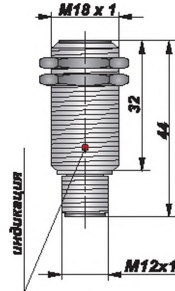
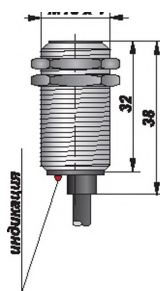

Sn 8

PNP ⓐ \_\_\_\_\_ -  
 \_\_\_\_\_ -  
 NPN ⓑ \_\_\_\_\_ -  
 \_\_\_\_\_ -

HB13-NO-PNP	01643	HB13-NO-PNP-P	01647	HB13-NO-PNP-K	01651	HB14-NO-PNP	01655
HB13-NC-PNP	1644	MB13-NC-PNP-P	01648	MB13-NC-PNP-K	01652	HB14-NC-PNP	01656
HB13-NO-NPN	01645	HB13-NO-NPN-P	01649	MB13-NO-NPN-K	01653	HB14-NO-NPN	01657
HB13-NC-NPN	01646	MB13-NC-NPN-P	01650	MB13-NC-NPN-K	01654	HB14-NC-NPN	01658

\_\_\_\_\_  
 \_\_\_\_\_  
 \_\_\_\_\_  
 \_\_\_\_\_  
 \_\_\_\_\_  
 \_\_\_\_\_  
 \_\_\_\_\_

10...30  
 400  
 2,1  
 300  
 10%  
 10%  
 -25 ...+75  
 IP87

16 (12 18 10

6)

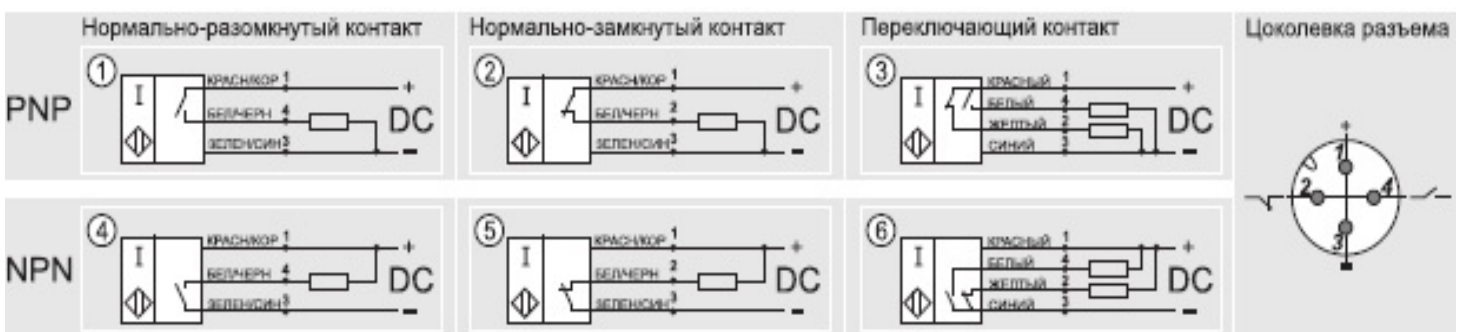

## M22 X 1,5

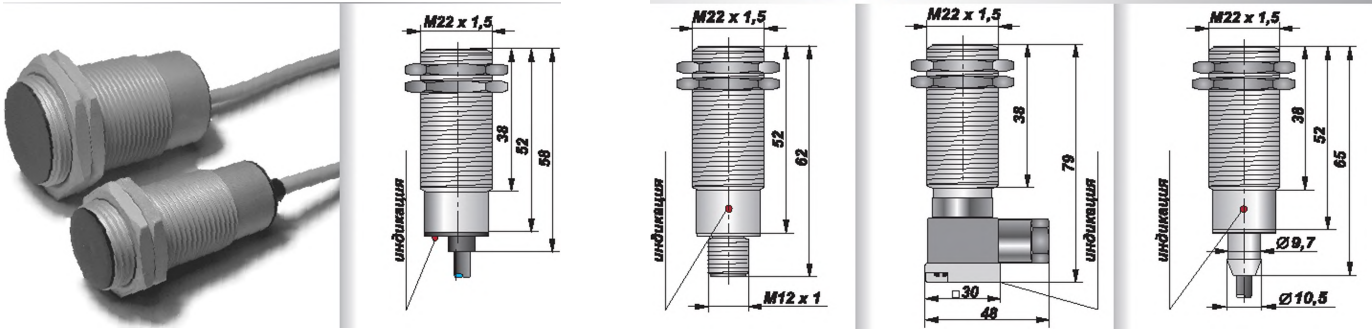

		Sn 10								
PNP		-	HB17-NO-PNP	01659	HB17-NO-PNP-P	01665	HB17-NO-PNP-K	01671	MB15-NO-PNP	01677
	@	-	HB17-NC-PNP	01660	MB17-NC-PNP-P	01666	HB17-NC-PNP-K	01672	MB18-NC-PNP	01678
	@	-	HB17-NO/NC-PNP	01661	17-NO/NC-PNP-P	01667	17-NO/NC-PNP-K	01673	MB18-NO/NC-PNP	01679
NPN		-	HB17-NO-NPN	01662	MB17-NO-NPN-P	01668	HB17-NO-NPN-K	01674	MB18-NO-NPN	01680
		-	HB17-NC-NPN	01663	MB17-NC-NPN-P	01669	MB17-NC-NPN-K	01675	MB18-NC-NPN	01681
	@	-	HB17-NO/NC-NPN	01664	17-NO/NC-NPN-P	01670	17-NO/NC-NPN-K	01676	MB18-NO/NC-NPN	01682

## 22 1.5

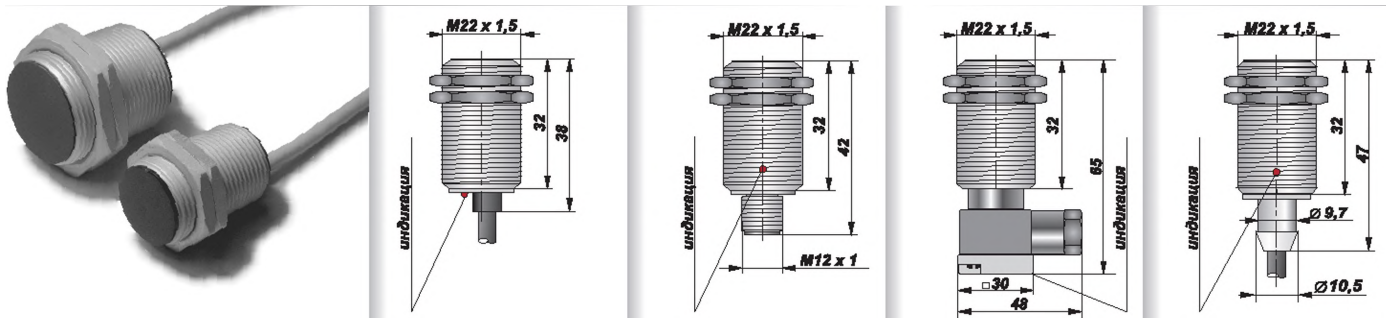

		Sn 10								
PNP		-	MB21-NO-PNP	01683	MB21-NO-PNP-P	01687	HB21-NO-PNP-K	01691	MB22-NO-PNP	01695
	@	-	MB21-NC-PNP	01684	MB21-NC-PNP-P	01688	21 -N C-PNP -	01692	MB22-NC-PNP	01696
NPN	@	-	MB21-NO-NPN	01685	HB21-NO-NPN-P	01689	HB21-NO-NPN-K	01693	HB22-NO-NPN	01697
		-	HB21-NC-NPN	01686	MB21-NC-NPN-P	01690	HB21-NC-NPN-K	01694	HB22-NC-NPN	01698

										10...30
										400
										2.1
										250
										10%
										10%
										-25 ...+75
										IP67
										16 (12 18 10 6)
										/ 4

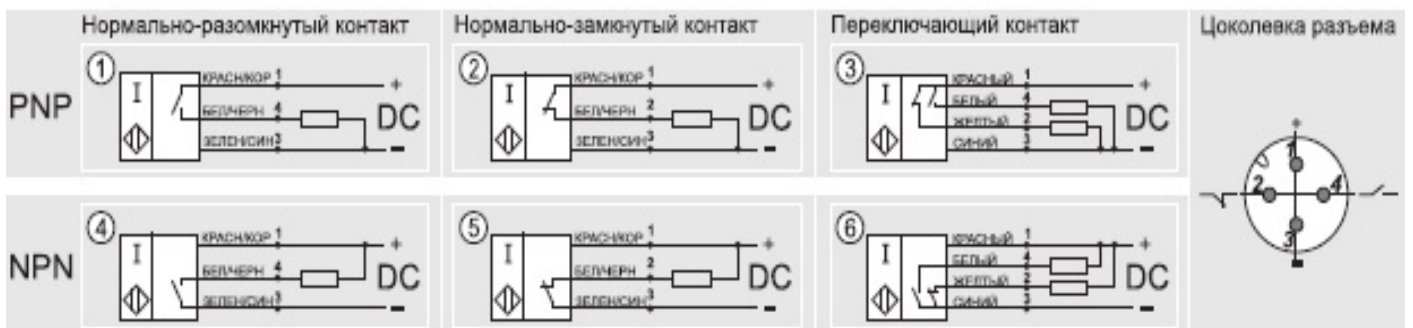



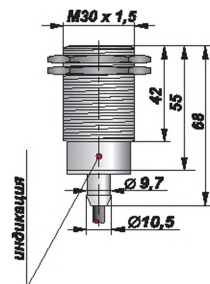
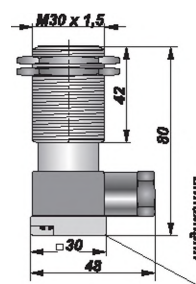
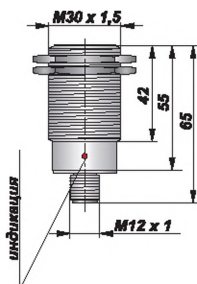
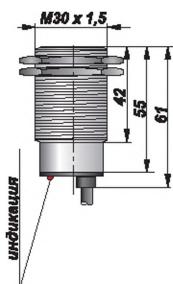

30 1.5

		Sn 15								
PNP	⊕	-	HB25-NO-PNP	01699	HB25-NO-PNP-P	01705	B25-N - N -	01711	HB26-NO-PNP	01717
	⊖	-	HB25-NC-PNP	01700	MB25-NC-PNP-P	01706	HB25-NC-PNP-K	01712	HB26-NC-PNP	01718
	⊖	-	HB25-NO/NC-PNP	01701	HB25-NO/NC-PNP-P	01707	HB25-NO/NC-PNP-K	01713	HB26-NO/NC-PNP	01719
NPN	⊕	-	HB25-NO-NPN	01702	MB25-NO-NPN-P	01708	HB25-NO-NPN-K	01714	HB26-NO-NPN	01720
	⊖	-	HB25-NC-NPN	01703	MB25-NC-NPN-P	01709	HB25-NC-NPN-K	01715	HB26-NC-NPN	01721
	⊖	-	HB25-NO/NC-NPN	01704	HB25-NO/NC-NPN-P	01710	HB25-NO/NC-NPN-K	01716	HB26-NO/NC-NPN	01722

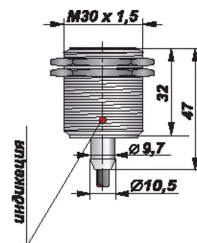
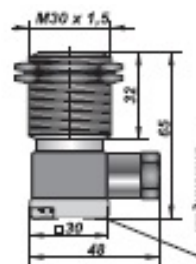
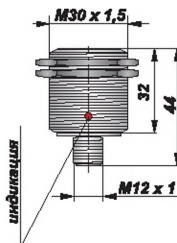
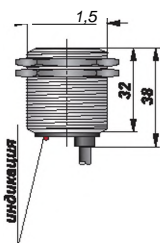
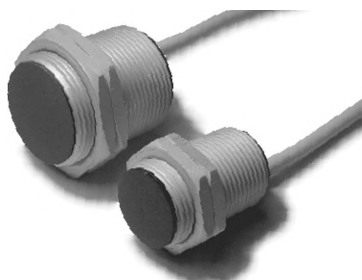

30 1.5

		Sn 15								
PNP	⊕	-	HB29-NO-PNP	01723	HB29-NO-PNP-P	01727	I4B29-NO-PNP-K	01731	-NO-PNP	01735
	⊖	-	HB29-NC-PNP	01724	HB29-NC-PNP-P	01728	MB29-NC-PNP-K	01732	-NC-PNP	01736
NPN	⊕	-	HB29-NO-NPN	01725	HB29-NO-NPN-P	01729	HB29-NO-NPN-K	01733	-NO-NPN	01737
	⊖	-	HB29-NC-NPN	01726	HB29-NC-NPN-P	01730	MB29-NC-NPN-K	01734	-NC-NPN	01738

						10...30			
						400			
						2,1			
						100			
						10%			
						10%			
						-25 ...+75			
						IP67			
						16 (12 18 10)		6)	
						/ 4			



## 30 1.5

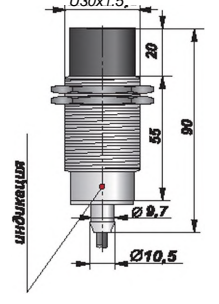
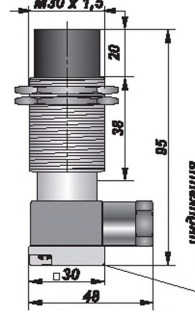
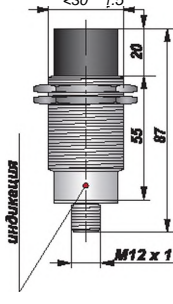
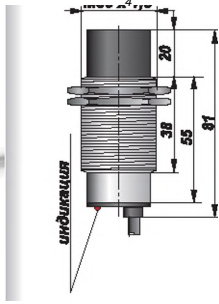

		Sn 20								
PNP	⊖	-	HB27-NO-PNP	01739	HB27-NO-PNP-P	01745	HB27-NO-PNP-K	01751	HB28-NO-PNP	01757
	⊙	-	MB27-NC-PNP	01740	HB27-NC-PNP-P	00176	HB27-NC-PNP-K	01752	HB28-NC-PNP	01758
	⊙	-	HB27-NO/NC-PNP	01741	HB27-NO/NC-PNP-P	01747	HB27-NO/NC-PNP-K	01753	HB28-NO/NC-PNP	01759
NPN	⊖	-	HB27-NO-NPN	01742	HB27-NO-NPN-P	01748	HB27-NO-NPN-K	01754	HB28-NO-NPN	01760
	⊙	-	HB27-NC-NPN	01743	HB27-NC-NPN-P	01749	HB27-NC-NPN-K	01755	HB28-NC-NPN	01761
	⊙	-	HB27-NO/NC-NPN	01744	HB27-NO/NC-NPN-P	01750	HB27-NO/NC-NPN-K	01756	HB28-NO/NC-NPN	01762

## 30 1.5

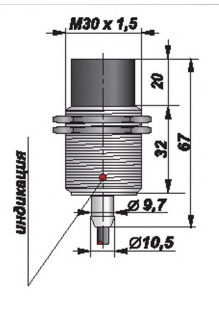
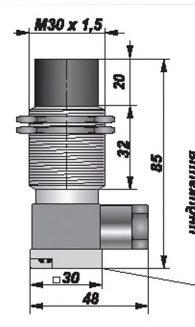
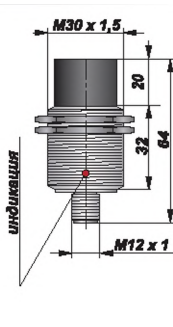
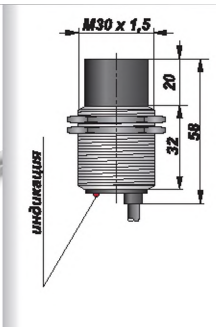

		Sn 20								
PNP	⊖	-	31-NQ-PNP	01763	31-NO-PNP-P	01767	31-NO-PNP-K	01771	I4B32-NO-PNP	01775
	⊙	-	HB31-NC-PNP	01764	I4B31-NC-PNP-P	01768	HB31-NC-PNP-K	01772	HB32-NC-PNP	1770
NPN	⊖	-	MB31-NO-NPN	01765	HB31-NO-NPN-P	01769	MB31-NO-NPN-K	01773	MB32-NO-NPN	01777
	⊙	-	MB31-NC-NPN	01766	HB31-NC-NPN-P	01770	MB31-NC-NPN-K	01774	MB32-NC-NPN	01778

					10...30
					400 /250
					2,1
					100
					10%
					10%
					-25 ...+75
					IP87
					16 (12 18 10 6)
					/

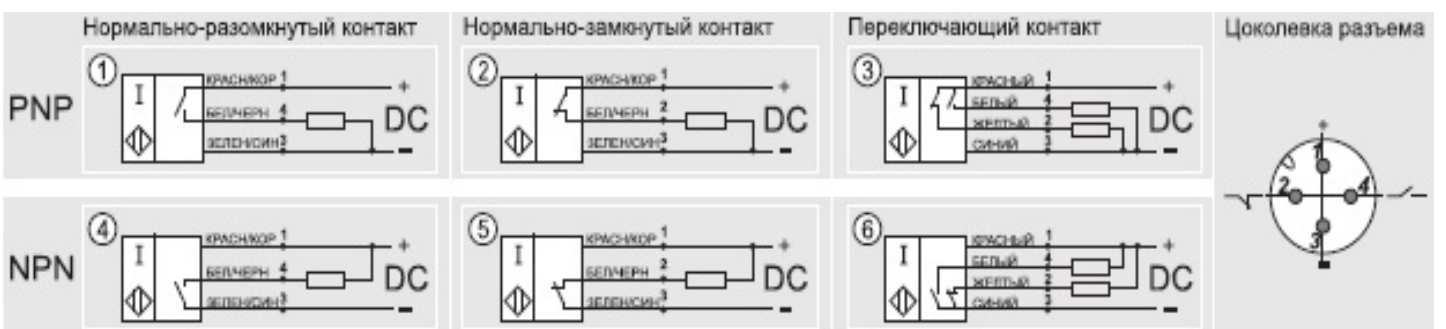

# 80X80X40

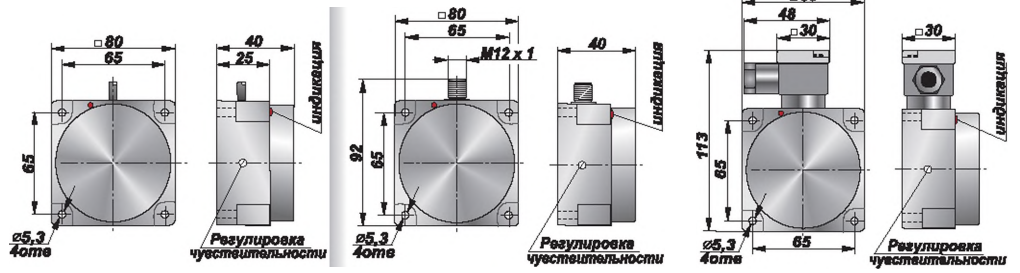

		Sn 0...80						
PNP	⊖	-	HB40-NO-PNP	01779	MB40-NO-PNP-P	01785	HB40-NO-PNP-K	01791
	⊕	-	HB40-NC-PNP	01780	MB40-NC-PNP-P	01786	HB40-NC-PNP-K	01792
	Ⓜ	-	HB40-NO/NC-PNP	01781	MB40-NO/NC-PNP-P	01787	HB40-NO/NC-PNP-K	01793
NPN	⊖	-	HB40-NO-NPN	01782	MB40-NO-NPN-P	01788	MB40-NO-NPN-K	01794
	⊕	-	MB40-NC-NPN	01783	MB40-NC-NPN-P	01789	MB40-NC-NPN-K	01795
	Ⓜ	-	HB40-NO/NC-NPN	01784	I4B40-NO/NC-NPN-P	01790	MB40-NO/NC-NPN-K	01796

10...30  
400  
2,1  
100  
10%  
10%  
-25 ...+75  
IP67

6

/« || \_\_\_\_\_ »

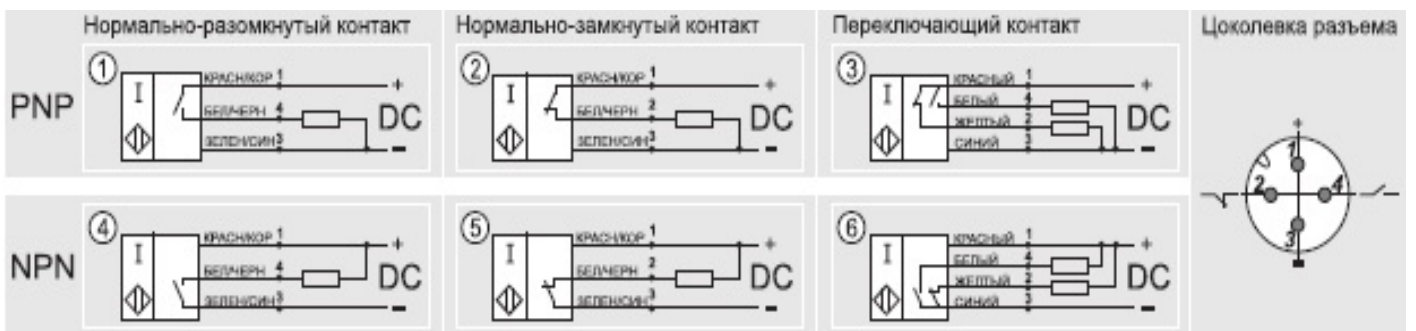

**По вопросам продаж и поддержки обращайтесь:**

Архангельск (8182)63-90-72  
Астана +7(7172)727-132  
Белгород (4722)40-23-64  
Брянск (4832)59-03-52  
Владивосток (423)249-28-31  
Волгоград (844)278-03-48  
Вологда (8172)26-41-59  
Воронеж (473)204-51-73  
Екатеринбург (343)384-55-89  
Иваново (4932)77-34-06  
Ижевск (3412)26-03-58  
Казань (843)206-01-48

Калининград (4012)72-03-81  
Калуга (4842)92-23-67  
Кемерово (3842)65-04-62  
Киров (8332)68-02-04  
Краснодар (861)203-40-90  
Красноярск (391)204-63-61  
Курск (4712)77-13-04  
Липецк (4742)52-20-81  
Магнитогорск (3519)55-03-13  
Москва (495)268-04-70  
Мурманск (8152)59-64-93  
Набережные Челны (8552)20-53-41

Нижний Новгород (831)429-08-12  
Новокузнецк (3843)20-46-81  
Новосибирск (383)227-86-73  
Орел (4862)44-53-42  
Оренбург (3532)37-68-04  
Пенза (8412)22-31-16  
Пермь (342)205-81-47  
Ростов-на-Дону (863)308-18-15  
Рязань (4912)46-61-64  
Самара (846)206-03-16  
Санкт-Петербург (812)309-46-40  
Саратов (845)249-38-78

Смоленск (4812)29-41-54  
Сочи (862)225-72-31  
Ставрополь (8652)20-65-13  
Тверь (4822)63-31-35  
Томск (3822)98-41-53  
Тула (4872)74-02-29  
Тюмень (3452)66-21-18  
Ульяновск (8422)24-23-59  
Уфа (347)229-48-12  
Челябинск (351)202-03-61  
Череповец (8202)49-02-64  
Ярославль (4852)69-52-93

сайт: <http://induction.nt-rt.ru> || эл. почта: [ick@nt-rt.ru](mailto:ick@nt-rt.ru)